



Smart strobe electronic



Very intense and **uniform** illuminated area

Full range of colors: from blue to IR, white

Long lifetime and few maintenances







Waterproof

Chainable: Double I/O connectors

Electronics	Connectors	2X M12 5 contacts (1 male & 1 female)
	Power supply	24V DC
	Illumination mode	Continuous or strobe mode
	Power consumption	6 LED: 15W / 12 LED: 30W / 36 LED: 80W
Optics	Wavelength	Single (from UV to IR, white)
Mechanics	Weight	6 LED: 180g / 12 LED: 300g / 36 LED: 800g
	Width x length x height	Depends on the amount of LED
	Fastener	4xM4 screw + 4xM3 screw + 2xM4 holes
	Material	Device body: Aluminum alloy & ABS; Window: PMMA
Environment	Working temperature	0°C to 45°C
	IP code	IP67

Part Number

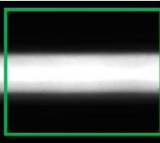

<p><i>Reference:</i> EFFI-SMART-WW-XXX-YY-ZZ</p>					
WW: Number of LED					
<p>06: 2X3 LED</p> 	<p>12: 2X6 LED</p> 	<p>36: 2X18 LED</p> 			
XXX: Wavelength (nm) / Color (other wavelengths available on request)					
● UV 405	● Blue 465	● Green 525	● Red 625	● IR 850	○ White 000 (T°= 5500 K ± 500 K)
YY: Type of window					
TR: Transparent		SD: Semi-Diffuse		OP: Opaline	
<i>If not specified, default semi-diffuse window</i>					
ZZ: Lens Position (emission angle depending on the lens position)					
P0: 90° (without lens)		P1: 45°		P2: 25°	
P3: 10°					
<i>If not specified, default position P2</i>					
Option Linescan (linear lighting or a darkfield lighting)			Option Polarizer (to eliminate glare caused by the lighting)		
  <p><i>Without Linescan</i> <i>With Linescan</i></p>			  <p><i>Without polarizer</i> <i>With polarizer</i></p>		
<p>If linescan, add -LS in the part number. Possibility to buy only the linescan.</p> <p>Part number: EFFI-SMART-WW-XXX-YY-ZZ-LS</p>			<p>If polarizer, add -POL in the part number. Possibility to buy only the polarizer.</p> <p>Part number: EFFI-SMART-WW-XXX-YY-ZZ-POL</p>		

Electronical considerations



Contact arrangement

The EFFI-Smart is supplied with a 24V constant voltage. Power consumption = **15 W** for the 6 LED version, **30 W** for the 12 LED version and **80 W** for the 36 LED version.

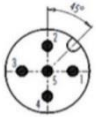
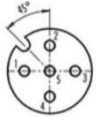
Pin Number	Cable color	Contact arrangement	Designation
1	Brown	  M12 Male connector M12 Female connector	Power supply: +24V Max current: 0.65A / 6LED; 1.25A / 12LED; 3.5A / 36LED
2	White		NPN (triggered on falling edge) - max 24V Max consumption = 0,1 mA
3	Blue		GND
4	Black		PNP (triggered on rising edge) - max 24V Max consumption = 2 mA
5	Grey		Analog Intensity Control: 0-10V - Max 24V Consumption = 1mA @10V & 2mA @24V



Modes

AIC pin	NPN pin	PNP pin	Mode	Designation
Not connected ≠0V	Not connected ≠0V	> 3Vdc, max 24Vdc	Auto-strobe ⁽¹⁾	Strobe control triggered on rising edge
Not connected ≠0V	< 1.5Vdc	Not connected ≠0V	Auto-strobe ⁽¹⁾	Strobe control triggered on falling edge
See DIMMING CONTROL Scheme	Not connected ≠0V	Not connected ≠0V	Dimming	LED OFF: 0V - 3V, ON: 3V (20%) – 10V (100%) & ON: 10-24V @100%
> 3Vdc, max 24Vdc	> 3Vdc, max 24Vdc	> 3Vdc, max 24Vdc	Test mode	LEDs are supplied with I _{max} until Default Temperature is activated. Do not use with external trigger, just for continuous Signal Consumption = 4mA  Do not touch the product! WARM!

(1): LEDs are supplied with I_{max} during 2s then with 40% of I_{max}

Dimming control

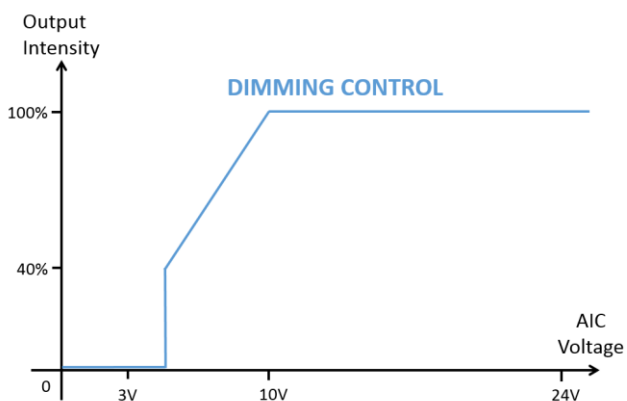

0V < U_{AIC} < 3V → LED OFF

3V < U_{AIC} < 10V → ≈40% < I_{LED} < 100%

10V < U_{AIC} < 24V → LED ON 100%

Characteristics of the pulse

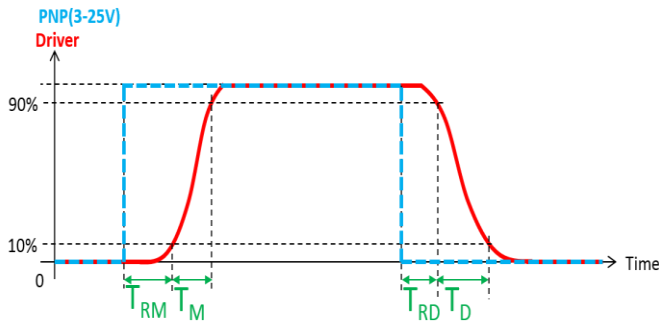

Designation	Time (μs)
Rise time (T_M)	10
Response rise time (T_{RM})	30
Fall time (T_D)	10
Response fall time (T_{RD})	30 (20 NPN)

⚠ A thermal security will trigger if the device gets too hot (long use at maximum power or duty cycle too strong, approx 20%).

Auto-Strobe

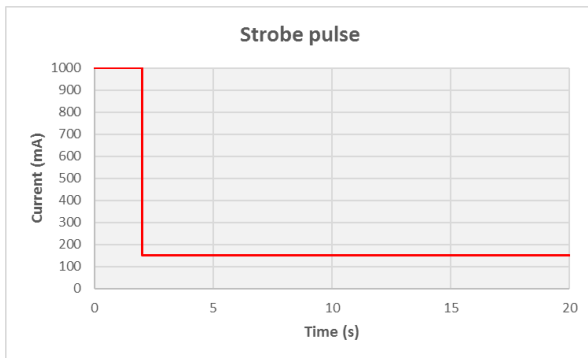

$0s < t_p < 2s \rightarrow I_{LED}=1000mA$
 $t_p > 2s \rightarrow I_{LED}=150mA$

N.B: For the strobe mode please respect a duty cycle (DC) lower than 0.25. A security is activated for $DC > 0.25$.
Duty cycle = $(ON\ TIME / (ON\ TIME + OFF\ TIME))$

LED indicator

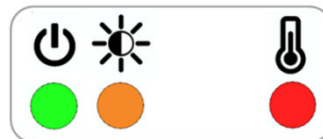

Green LED ON: Power Supply Connected

Red LED ON: Default Temperature at 65°C

⚠ Do not touch the product! Please wait 5 minutes before handling the product again.

Orange LED ON: Mode

Mode	Frequency
PNP & NPN	Flash at the light frequency
AIC	Flash at 1 Hz
TEST	Flash at 6 Hz

Optical considerations



Lens position

There are 4 lens positions, P0, P1, P2 and P3 for 4 different emission angles

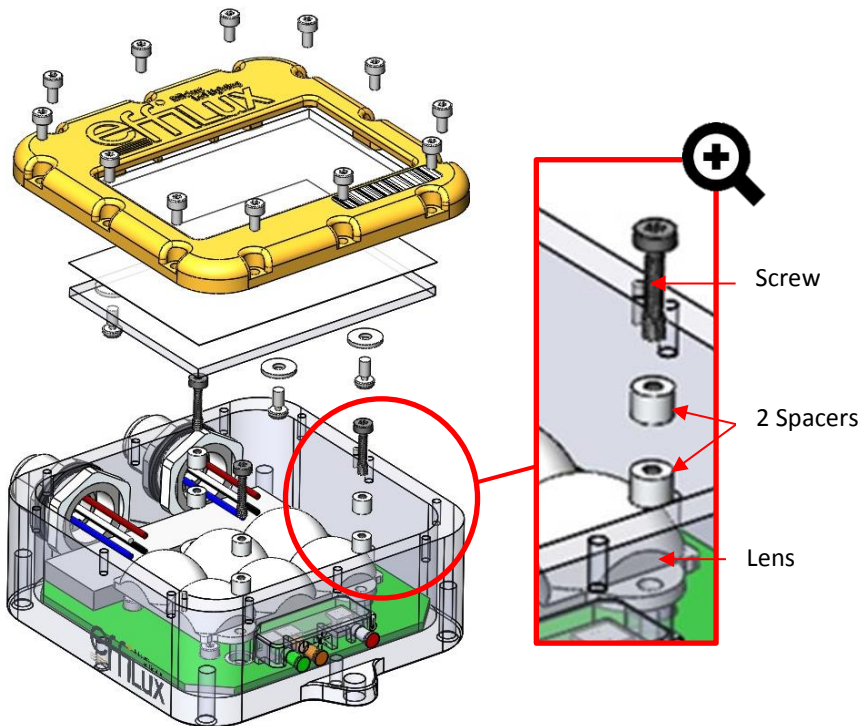

(Scheme: P1 configuration)

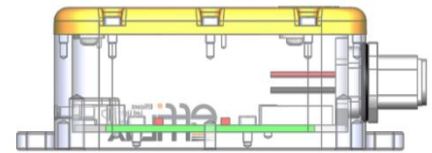

P0: without lens

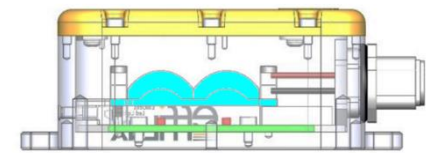

P1: screw+spacer+spacer+lens

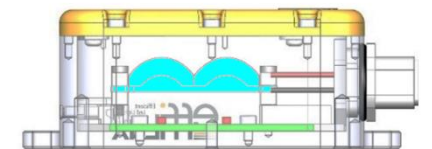

P2: screw+spacer+lens+spacer

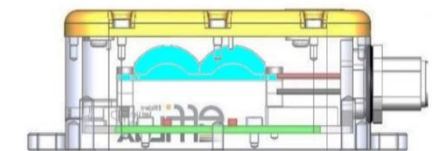

P3: screw+lens+spacer+spacer

Handle & clean optical components

To handle optical components, wearing gloves is strongly recommended.

To clean the optical components:

- Use compressed air duster if there is dust.
- To remove marks on the lens or the window, just a drop or two wiped of alcohol based lens cleaning fluid in a gentle circular motion with a cleaning tissue. Always apply the fluid to a tissue rather than on the lens itself.

Evolution of illuminance with different optical configurations

Measurements for white LED

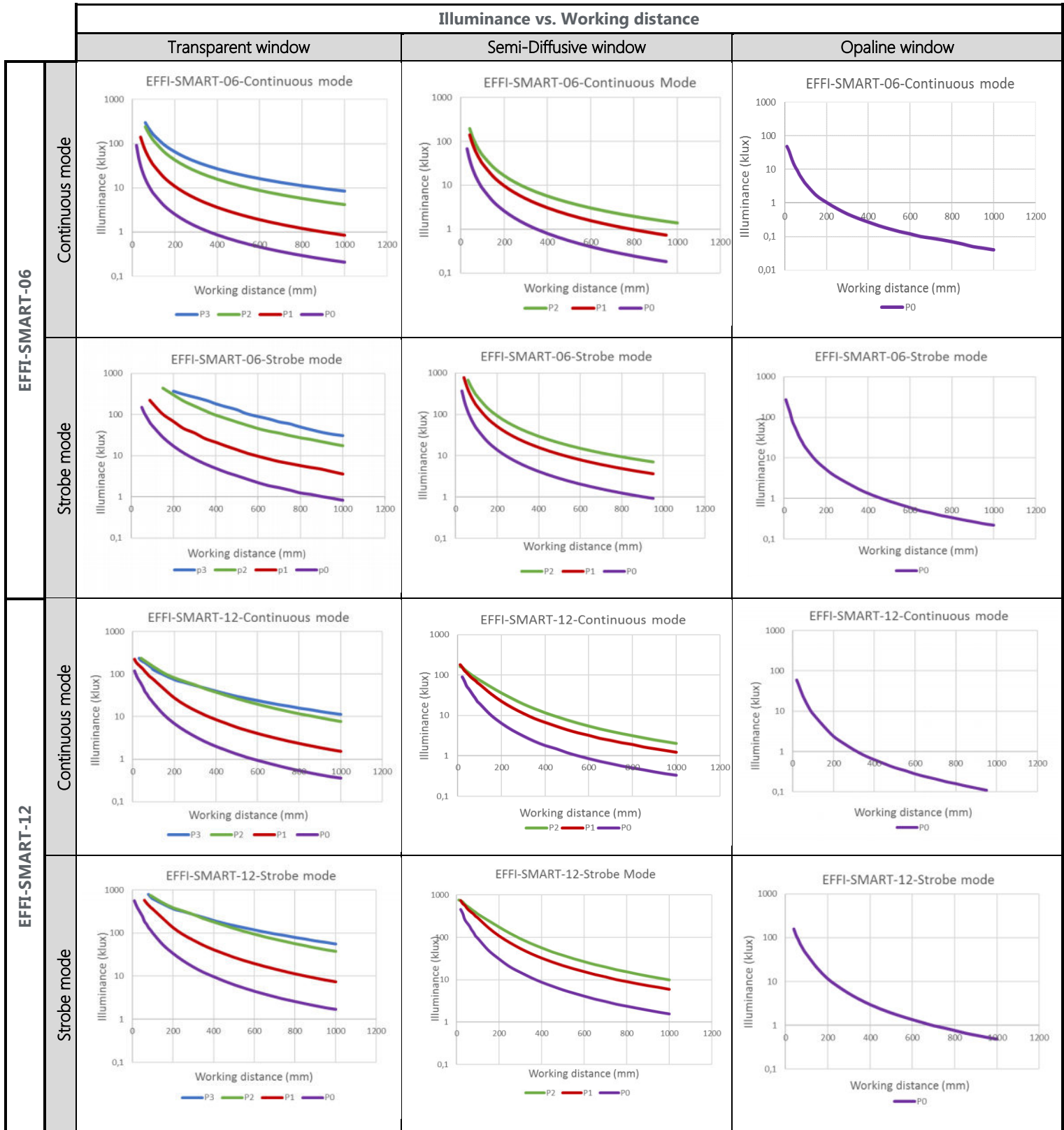

With Semi- Diffuse glass, there is no differences between P2 and P3. With Opaline glass there is no differences between P0, P1, P2 and P3. There is a ratio of 5 between illuminance of the strobe mode and the continuous mode.

Evolution of illuminance with different options

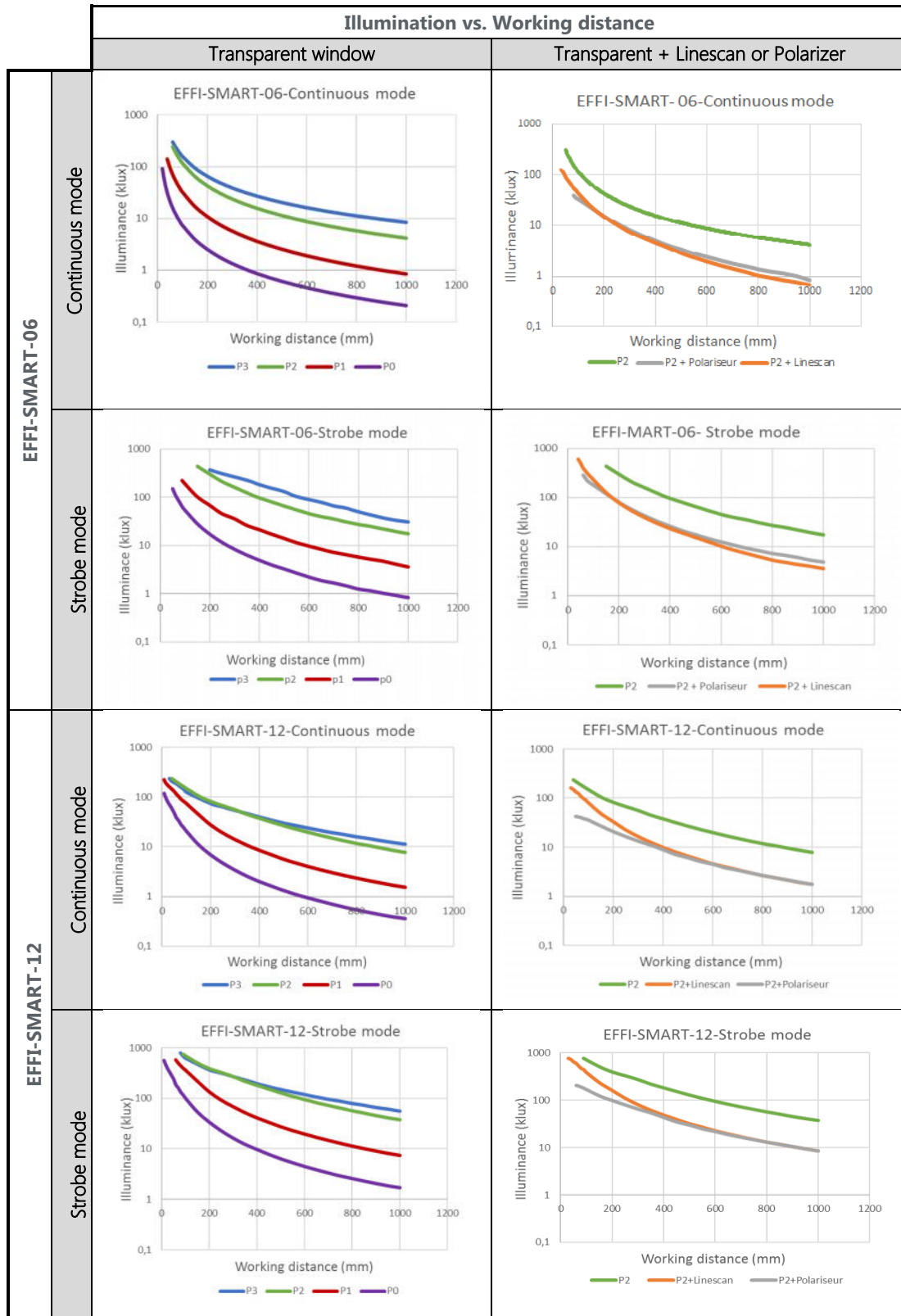

Power factor for different color (wavelengths)

Color	WHITE	RED	GREEN	BLUE
Power factor	1	/	/	/

Evolution of the illuminance with different options

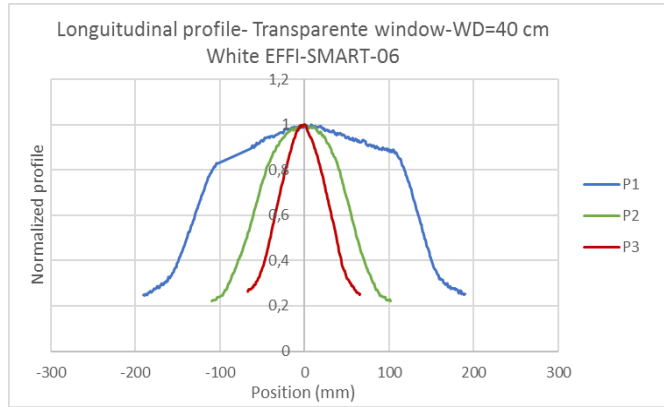
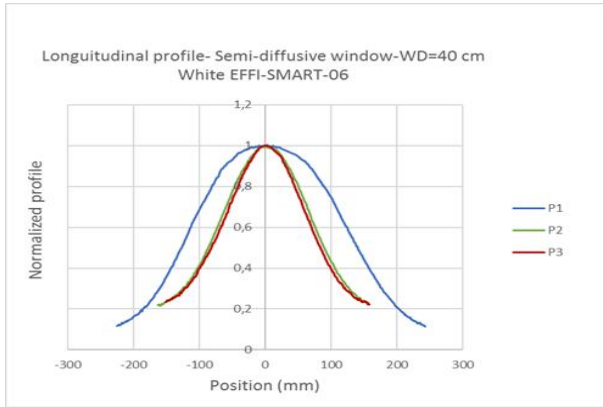

Longitudinal and transverse profile are similar for the EFFI-SMART-06.

Evolution of the illuminated surface

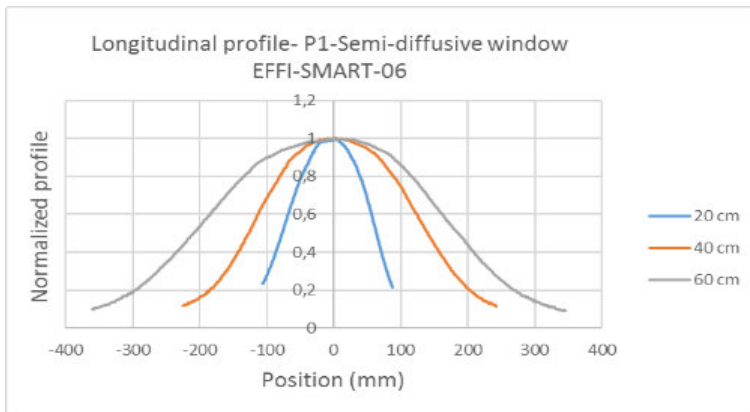

Longitudinal and transverse profile are similar for the EFFI-SMART-06.

For the EFFI-SMART-12/36 the transverse profile is approximatively the same. And the longitudinal profile will be proportional to the length of the product.

Evolution of the illuminated surface with different options

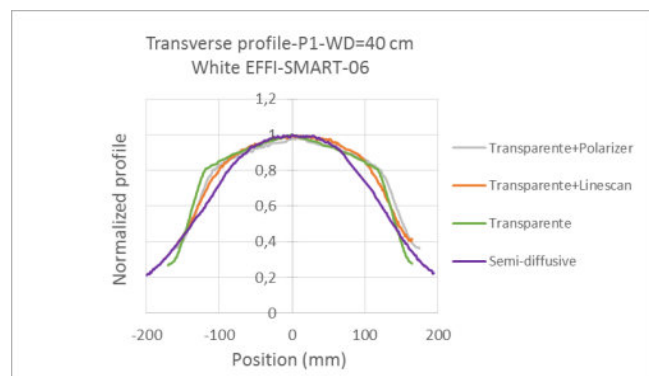
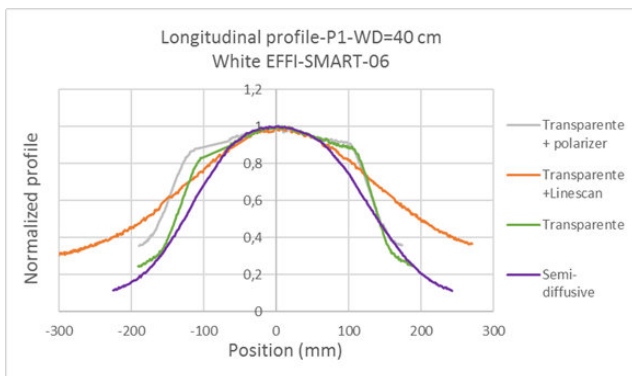

Mechanical considerations



EFFI-SMART-06

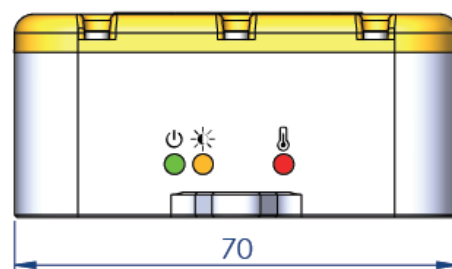
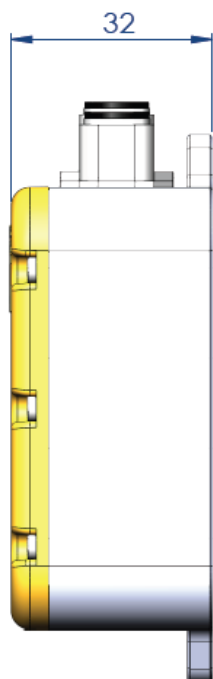
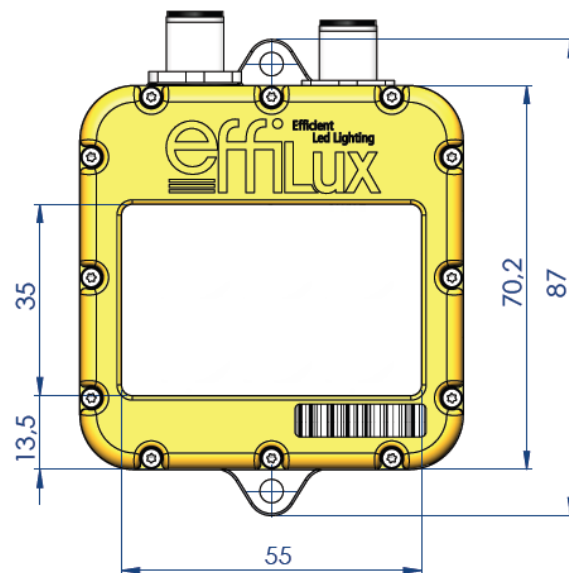
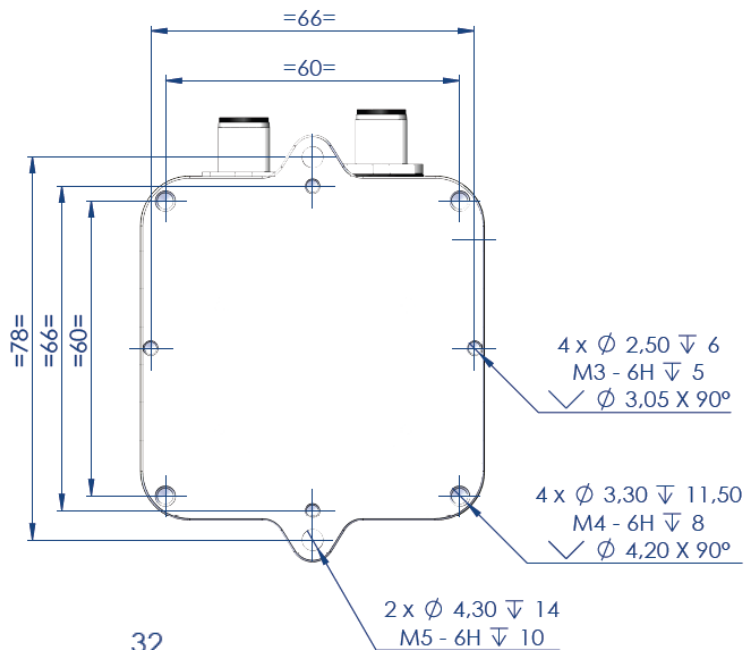

EFFI-SMART-12

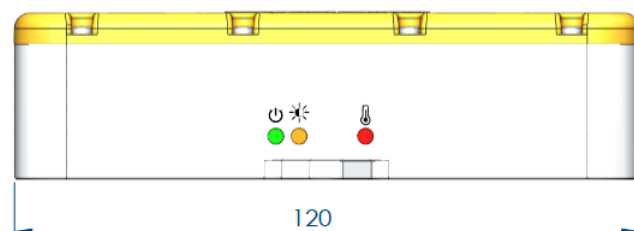
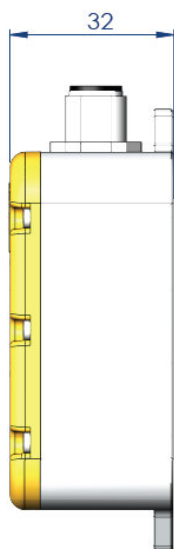
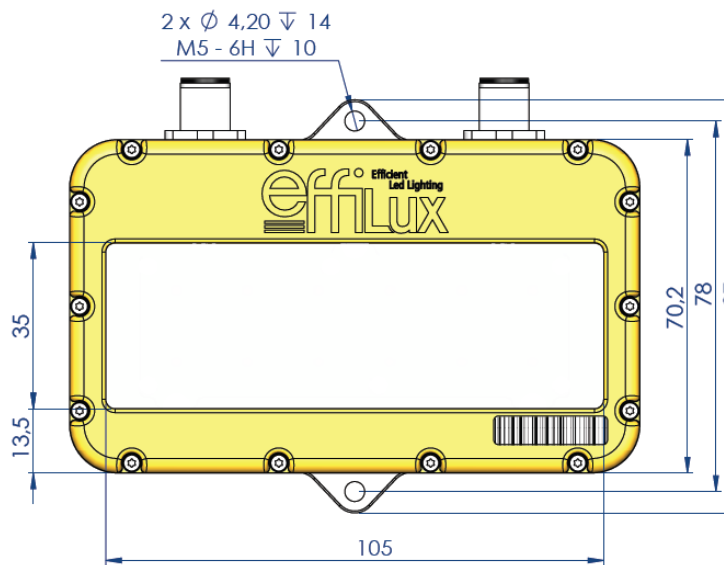
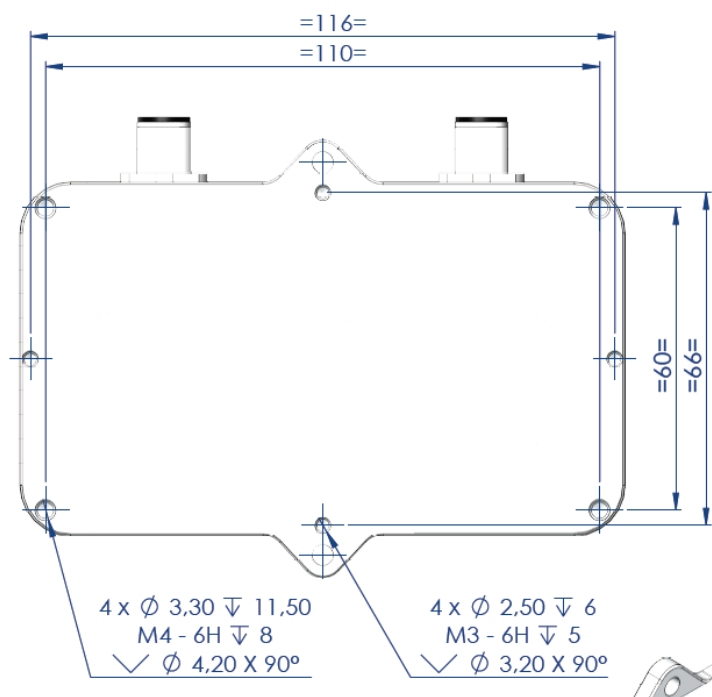

EFFI-SMART-36

